

Avidyne Corporation

**Multi-Hazard Display
Pilot Operating Handbook**

**Tactical Weather Detection System
(TWX670)**

Part Number: 600-00166-000
Revision: 0.04
Date: 10Mar2008

Supplement to the Avidyne Multi-Hazard Display
Pilot Operating Handbook - General Information

© 2004-2008
Avidyne Corporation
4800 Evanswood Drive
Columbus, Ohio 43229
(614) 885-3303
www.avidyne.com

Table of Contents

CHAPTER 1: GENERAL INFORMATION	5
REVISION INDEX	6
WELCOME	6
TSO INFORMATION	6
POLARIZED SUNGLASSES	7
CONVENTIONS USED IN THIS MANUAL	7
CHAPTER 2: FAST START	11
CHAPTER 3: BASIC OPERATION	15
PRODUCT DESCRIPTION	16
STARTUP	18
DISPLAY BRIGHTNESS	18
CONTROL BACKLIGHTING	18
CONTROLS	18
SINGLEVIEW AND MULTIVIEW MODES	20
CHAPTER 4: TWX DISPLAY	23
APPLICATION IDENTIFICATION	24
HOST AIRCRAFT SYMBOL	24
HOST AIRCRAFT OFFSET	24
DISPLAY RANGE	25
THUNDERSTORM PRESENTATION	26
Strike Mode	26
Cell Mode	26
Strike + Cell Mode	27
REGION ACTIVITY	27
HEADING INDICATOR	28
CLEARING AND RESTORING THE DISPLAY OF LIGHTNING DATA	29
CHAPTER 5: MENUS AND CONTROLS	31
MENU BASICS	32
The Main Menu	32
The Quick Menu	33
THE TWX APPLICATION MENU	34
THE SYSTEM MENU	37



CHAPTER 6: SPECIFICATIONS & WARRANTY 39

GENERAL SPECIFICATIONS OF THE MHD 40
PARTS AND SERVICE WARRANTY..... 40
CUSTOMER SUPPORT 41
RECORD OF PURCHASE 41

CHAPTER 7: APPENDICES 43

ERROR AND WARNING CONDITIONS 44
 Error Conditions 44
 Warning Conditions 46
 TWX670 Processor Failure 48
 Abnormal Operating Conditions 48
GLOSSARY 49
INDEX..... 51



CHAPTER 1

General Information

Revision Index

Revision	Date	Description of Change
0.00	23Oct2006	Initial Release
0.01	15Aug2007	Various minor corrections for consistency and rewordings for clarity. Added the Heading Indicator section in Chapter 4.
0.02	11Dec2007	Added TSO-C110A compliance
0.03	14Feb2008	Added a warning to the end of chapter 1. Added a list of error annunciations.
0.04	10Mar2008	TWX warnings now cause host symbol to change to an amber 'W'. Added list of warning indications that can be seen in the test dialog.

Part Number: 600-00166-000

Document Number: 87-3456

Welcome

Thank you for choosing the Avidyne Multi Hazard Display (MHD) with the Avidyne Tactical Weather Detection System (TWX670) Application. This Operating Handbook is intended as a guide to the capabilities and operation of the Avidyne MHD/TWX Application system. This manual will help you get the best performance from your system.

This manual should be used with Avidyne's *TWX670 Pilot Operating Handbook*. Refer to this guide for the Avidyne MHD/TWX670 display interface limitations.

Refer to the Avidyne *Multi-Hazard Display Pilot Operating Handbook - General Information* for information common to all applications of the MHD. Refer to Avidyne's *TWX670 Pilot Operating Handbook* for information about operating and interpreting the TWX670 information.

TSO Information

The Avidyne MHD complies with the requirements of TSO-C113, Airborne Multipurpose Electronic Displays. When installed with the Avidyne TWX670, the MHD complies with the requirements of



TSO-C110A. The Avidyne MHD and the Avidyne TWX Application software were developed to the requirements of DO-178B level D.

The conditions and tests required for TSO approval of the Avidyne MHD are minimum performance standards. It is the responsibility of those installing the Avidyne MHD either on or within a specific type or class of aircraft to determine that the aircraft installation conditions are within certification standards. The Avidyne MHD may be installed only if the installation is performed in accordance with 14 CFR Part 43 or the applicable airworthiness regulations.

Polarized Sunglasses

The liquid crystal display is not compatible with polarized sunglasses.

Conventions Used in this Manual

- **Bold** is used to denote a menu item, which can be activated with a soft key.
- *ITALIC CAPITALS* are used to identify labeled controls such as the *VIEW/BRT* knob and the *MENU* pushbutton.
- “Quotation marks” are used to highlight specific wording as it appears on the LCD screen.
- The location of a particular menu or dialog is specified as a sequence of buttons, menus, and dialogs separated with ‘/’. This is called the path to the menu or dialog. For example, Cell mode can be selected with the path *MENU/Quick/Mode/Cell*. This path indicates a press the *MENU* button, followed by a press of the soft key labeled **Quick**, then the one labeled **Mode**, and finally the one labeled **Cell**.
- A knob can be rotated and pushed.
- A button can be pushed or held.
- A Menu is a set of options displayed at the bottom of the screen that indicates the current function of each soft key. Each menu also has a title that is displayed to show the

functional grouping of its options. When a menu is displayed, the system is said to be in menu mode.





WARNING: The TWX670 provides information that approximates storm location and strength. This information is advisory only; the aircraft must not be maneuvered based solely by reference to this information.

CHAPTER 2

Fast Start



The operation of the MHD is generally intuitive and there is more than one way to access many functions. The following is an overview of the operation of the MHD with the TWX Application.

- Turn the unit on by pressing the *VIEW/BRT* knob (left rotary knob).
- Turn the unit off by pressing and holding the *VIEW/BRT* knob.
- Twist the *VIEW/BRT* knob to adjust display brightness. (The cockpit dimmer controls knob brightness.)
- Press the *VIEW/BRT* knob to switch between singleview mode and multiview mode. Multiview mode includes two thumbnail windows for displaying applications. If the system consists of only one application, the thumbnail images may be blank.
- Twist the *DATA/RNG* knob (right rotary knob) to adjust the range.
- Pressing any soft key button accesses the “TWX - Quick Menu” which is used to temporarily mute audio call-outs, clear or restore strike and cell data, or select the TWX670’s display mode.
- Press *MENU* to invoke the TWX Application menu, which provides access to display configuration options as well as other information about the TWX670 processor. The menu options appear above the soft key buttons.
- Figure 5.3 on page 34 shows the overall structure of the TWX Application menu.
- In Strike mode, lightning strikes are plotted on the display relative to aircraft heading. Individual strikes are depicted with a color gradient where the color represents the intensity of storm activity in the region where the strike was detected. Strikes detected in the strongest regions of the storm are plotted in red, while strikes in the weakest region of the storm are plotted in blue. See Figure 2.1



- In Cell mode, individual strikes are integrated together into a composite view of the storm. Cell locations are plotted on the display relative to aircraft heading to provide a colored contour map of storm activity. As with strike depiction, regions of strongest storm activity are shown in red, while the weakest regions are shown in blue. See Figure 2.2.
- Press the *DATA/RNG* knob (right rotary knob) to display the strike rate and trend for regions of storm activity.

FIGURE 2.1

Strike mode shows individual strike locations



FIGURE 2.2

Cell mode provides a contour of overall storm activity

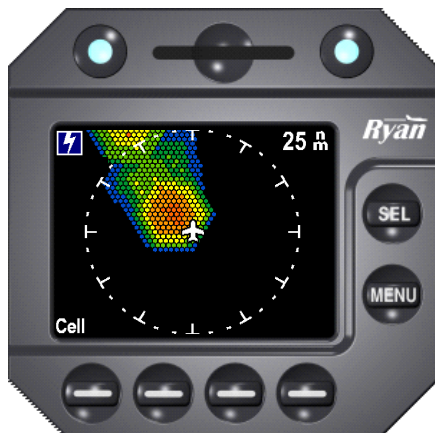

(This page was intentionally left blank)



CHAPTER 3

Basic Operation



Product Description

The Avidyne Multi-Hazard Display (MHD) consists of a rugged high-resolution Active Matrix Liquid Crystal Display (AMLCD) with anti-glare lens, Light Emitting Diode (LED) backlit optical rotary knobs, and tactile electroluminescent (EL) pushbuttons. The MHD receives inputs from the pilot and provides visual and tactile feedback. Refer to Figure 3.1 and Figure 3.2 below.

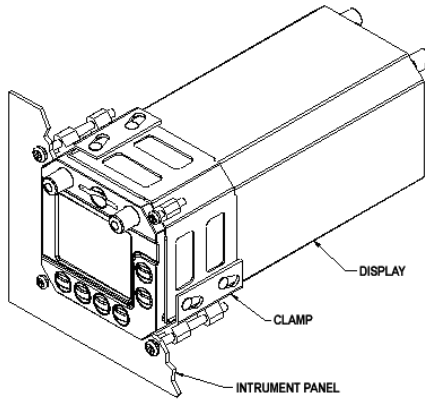

FIGURE 3.1
Multi-Hazard
Display,
Illustrating the
Instrument Panel
Mounting
Arrangement

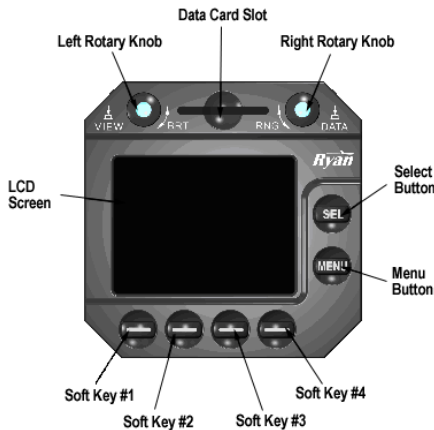

FIGURE 3.2
The MHD
Controls

The MHD serves as a common location to display aviation hazards while reducing clutter on navigation displays. Many hazards are better viewed at ranges that differ from those preferred on moving map displays. Surrounding terrain, for instance, is optimally viewed at less than twenty miles. Traffic is best viewed at five to ten miles. Satellite and lightning weather is normally viewed at two hundred miles or more. Thus, when hazard information is overlaid on a navigation map, an optimal range setting is impossible for all data, and vital information may be so cluttered as to reduce effective communication to the pilot.

The Avidyne MHD presents each hazard individually, allowing the flight crew to optimize the range of each application while minimizing the space used to display them. An individual application can be shown full screen, or multiple applications can be viewed three at a time with each in its own separate window on the display screen.

The MHD TWX Application communicates with an external TWX670 processor to display lightning strike or cell data. The system is designed to operate with minimal pilot interaction.



CAUTION: The Avidyne MHD TWX Application is advisory only and is designed to enhance situational awareness. Refer to the current Avidyne *TWX670 Pilot Operating Handbook* for information pertaining to operating and interpreting the TWX670 information depicted on the MHD.

Startup

The MHD turns on automatically with the avionics master switch, or with a press of the *VIEW/BRT* knob (left rotary knob). It may take 20 seconds or more to display an image. At low temperatures the startup time may be slightly longer. If the system appears not to have turned on, check the brightness setting of the display by turning the *VIEW/BRT* knob clockwise. Press and hold the same button to turn the unit off.

Display Brightness

The brightness of the display may be adjusted by twisting the *VIEW/BRT* knob (left rotary knob).

Control Backlighting

The pushbuttons and rotary knobs are backlit. The intensity of the control backlighting can be adjusted using the panel dimmer controls in the cockpit (if connected during installation). The buttons use reflective technology for daytime viewing and active backlighting for night operations. By design, the backlighting is very dim and appears to change very little when adjusting with the panel dimmer, especially compared to the knobs.

Controls

The following table summarizes the control functions of the display with the TWX Application. Refer to Figure 3.2 for an image of the MHD with the controls labeled. Refer to the *Multi-Hazard Display Pilot Operating Handbook - General Information* for a detailed description of the basic MHD controls.

The operation of the unit is designed to be intuitive, with quick access to the most commonly used functions. To aid in the intuitive operation it is possible to accomplish some functions in more than one way. Use this guide with the display in order to understand the operation and explore all the functions. Once the process is understood it will normally not be necessary to refer to this table for operation.

Button (and Action)	Function in the TWX Application
Left Rotary Knob (twist)	Adjusts brightness of the LCD.
Left Rotary Knob (momentary press)	<p>Toggles the display between singleview mode and multiview mode. Pressing the button when a dialog is displayed saves and exits the dialog.</p> <p>When the MHD is turned off, pressing this knob turns it on.</p>
Left Rotary Knob (press for 6 - 10 seconds)	Turns the MHD off.
Right Rotary Knob (press)	<p>Clears all current thunderstorm data from the display. New strikes will continue to be accumulated and displayed normally.</p> <p>When a menu is being presented, pressing the knob closes the menu and returns to the normal viewing mode</p>
Right Rotary Knob (twist)	Changes the display range for the thunderstorm data.
SEL, multiview mode (press)	Rotates the applications between the multiview mode windows (see Figure 3.4). When only one application is installed, the thumbnail windows may be blank.
SEL, singleview mode (press)	Rotates the applications from the main display to the background (that is, operating but not displayed). When only one application is installed, the SEL button has no apparent function in singleview mode.
MENU (press)	<p>When not in menu mode, this button invokes the menu for the primary application.</p> <p>When in menu mode, this button causes the next higher menu in the menu hierarchy to be displayed.</p>



Button (and Action)	Function in the TWX Application
Soft Key (press)	<p>When not in menu mode, the soft keys invoke the Quick Menu for the primary application.</p> <p>When in menu mode, pressing a soft key activates the corresponding menu option shown on the screen just above the soft key.</p>

Singleview and Multiview Modes

There are two basic display modes: singleview mode and multiview mode. Pressing the *VIEW/BRT* knob switches the display between the two modes.

Singleview mode presents a full screen display of a single application. While in singleview mode, different applications are selected sequentially using the *SEL* button.

Figure 3.3 shows an example of the TWX Application in singleview mode. In the example, several regions of storm activity are shown at the 1:00 position starting at 30 nm. More activity is shown at the 9:30 position starting around 25 nm. The 9:30 activity is more severe than the 1:00 activity.



FIGURE 3.3
Singleview mode showing TWX data



Multiview mode can show up to three applications at once. The primary application is presented in the large display area (the multiview main window), and two secondary applications are presented in small thumbnail windows. Pressing the *SEL* button while in multiview mode rotates application positions clockwise. Each press of the *SEL* button moves the secondary application in the upper thumbnail into the main window, making it the primary application (see Figure 3.4).

Figure 3.4 shows an example of multiview mode with TWX as the primary application and DME and traffic as secondary applications displayed in the thumbnail windows. The arrows in Figure 3.4 show the rotation sequence that occurs when the *SEL* button is pressed.

FIGURE 3.4
Multiview mode showing TWX, Traffic, and DME (arrows indicate rotation sequence as *SEL* is pressed)



(This page was intentionally left blank)



CHAPTER 4

TWX Display



Application Identification

The lightning icon  in the upper left corner of the display region identifies the displayed data.

Host Aircraft Symbol

The host aircraft is depicted using a white aircraft symbol. The preferred shape of the host symbol can be selected in the Host Symbol dialog, accessible via the System Menu. Helicopters or fixed wing aircraft can be selected. To access the Host Symbol dialog press *MENU/MENU/System/Prefs/Hosts...* See CHAPTER 5 for details about the System Menu structure.

Host Aircraft Offset

The host aircraft offset allows lightning data to be presented in different display formats. The **Center** offset selection places the aircraft symbol at the center of the display to show the thunderstorm data 360° around the aircraft. See Figure 4.1 for an example of the center host offset.

The **Rear** offset selection moves the aircraft symbol toward the bottom (or rear) of the display providing the best view in the forward direction. See Figure 4.2 for an example of the rear host offset.

The TWX Application allows the host symbol offset selection to be set independently for the singleview and multiview display modes.

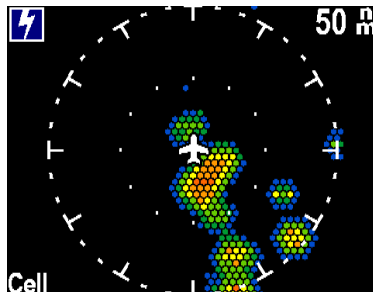
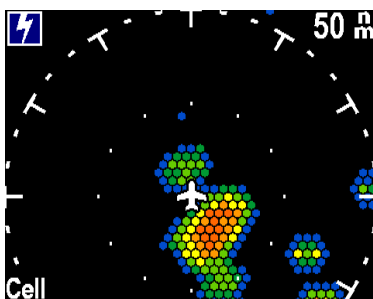

FIGURE 4.1

The center offset, displaying storm activity equally in all directions

FIGURE 4.2

The rear offset permits a larger view in the forward direction



Display Range

When TWX is the primary application, the current display range is shown in the upper right corner. This value corresponds to the distance between the host aircraft symbol and the outer range ring on the display. The selected display range is shown in all view formats including the thumbnail. An inner range ring at 25 nm is included for all range selections greater than 25 nm.

The display range is adjusted by rotating the *DATA/RNG* knob (right rotary knob). Ranges of 10, 25, 50, 100 and 200 nm are available. During range adjustments, the range label is momentarily duplicated on the left side of the outer range ring (see Figure 4.3). The duplicate range label is provided for convenience, since the user's hand may obstruct the view of the upper right corner of the LCD screen while the knob is used.

FIGURE 4.3

The display range is momentarily duplicated on the left side of the display when adjusting the range.



The display range of a thumbnail application is not adjustable with the *DATA/RNG* knob; however, the thumbnail application may be

rotated to the multiview main window for such range adjustment and then rotated back to a thumbnail window afterwards. Alternatively, for the TWX Application, the user may navigate to and use the “TWX - Display Range” menu.

Thunderstorm Presentation

The TWX670 has two basic modes to depict thunderstorm data: Strike mode and Cell mode. **Strike** or **Cell** mode can be selected using the Quick Menu (refer to CHAPTER 5 for more on using the menus). The selected mode is displayed in the lower left corner when the TWX Application is the primary application (it is omitted from the thumbnail view). A combined **Strike + Cell** mode is also available.

Strike Mode

Strikes are displayed with a color that indicates the intensity of strikes in its vicinity. Strike intensity is displayed with 7 different color shades ranging from red to blue. A strike displayed in red indicates an area of very high intensity, while a strike displayed in blue indicates an area of low intensity. See Figure 4.4 for an example of the Strike mode display.

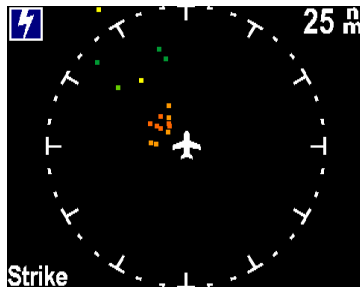

FIGURE 4.4

Strike display mode uses color to show regions of greater intensity

Cell Mode

Cell mode displays areas of thunderstorm activity and uses a similar color scheme to Strike mode. Red indicates areas of very high storm intensity; blue indicates areas of relatively low storm intensity. Figure 4.5 shows a typical Cell mode display.

The individual strikes that make up the Cell mode presentation are maintained for 3 minutes. Over time, the storm cell will either be

maintained (or grow) with the addition of newer strikes, or it will diminish as older strikes are discarded.

FIGURE 4.5

Cell display mode uses color mapping to improve overall situational awareness

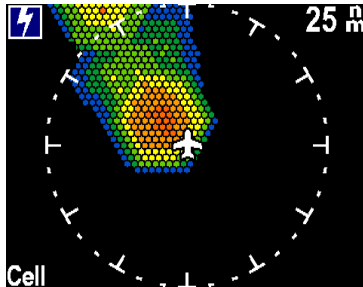

Strike + Cell Mode

Strike and Cell data can be overlaid onto a single presentation. An example of such a display is shown in Figure 4.6. In this display mode, strikes shown as flashing white dots overlay the colored cell data.

FIGURE 4.6

Combining Strike and Cell modes provides a better view of the storm's makeup

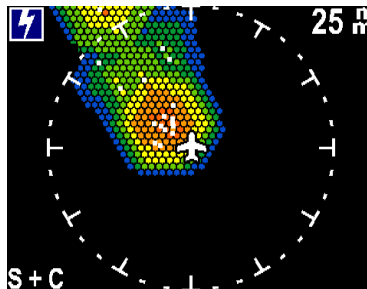

Region Activity

The severity of storm activity on a region by region basis can be determined by pressing the *DATA* button in the upper right corner. The display will show the strike rate and trend for the indicated region of storm activity on the screen as shown in Figure 4.7. In the example shown, the strike rate for the region is 7 strikes per minute, and the rate is increasing. Pressing the *DATA* button again will cause the display to sequence to the next storm region on the display. For display purposes, a region is defined as a contiguous area of cells consisting of dark green elements up to red elements (excluding blue

elements, the lowest intensity component of a cell). Region statistics only apply to that portion of the storm that is presented on the display. To examine a region that extends beyond the display range, go to the next higher range setting.

FIGURE 4.7

Region data provides indication of strike rate and whether the rate is increasing or decreasing

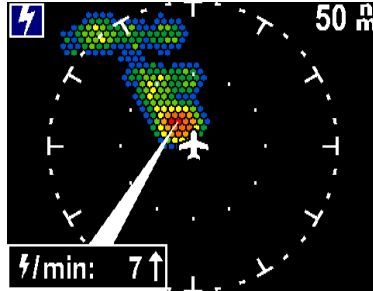

Heading Indicator

When the TWX670 processor is connected to a source of heading data, it can transmit the heading information. When TWX is the primary application, heading is displayed at the top of the window (see Figure 4.8).

FIGURE 4.8

Heading is displayed at the top of the screen when the TWX670 is connected to a heading source

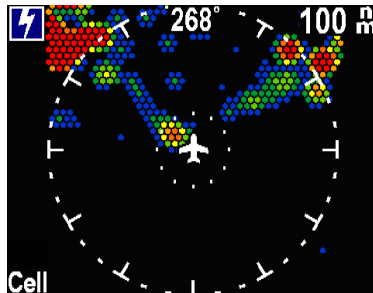

Note that heading stabilization and GPS stabilization of lightning data by the TWX670 processor can be manually disabled through the use of the TWX Stabilization dialog (accessible via MENU/Config/Stab..), although disabling the stabilization is normally done only when the data sources are suspected to be malfunctioning and thus resulting in an erratic TWX display.

Clearing and Restoring the Display of Lightning Data

The display can be cleared of current strike and cell data by using the **Clear** selection on the Quick Menu. Clearing the display can help to determine if a storm is building or receding by allowing the user to observe the rate at which new strikes are accumulated. The **Restore** selection on the Quick Menu can be used to restore the last three minutes worth of strike and cell data to the display.

(This page was intentionally left blank)



CHAPTER 5

Menus and Controls

Menu Basics

Menus on the Avidyne MHD appear at the bottom of the display and consist of a menu title and four button labels (see Figure 5.1). Pressing the soft key below one of the button labels will perform the corresponding action.

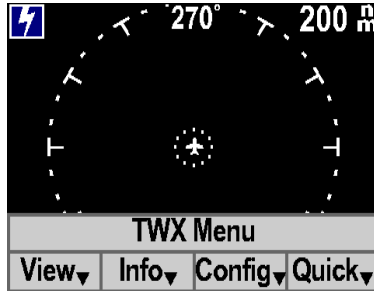

FIGURE 5.1

Accessing the TWX Application menu

During normal operation the menus are hidden in order to maximize the screen area for useful data. The menu bar can be accessed in two ways.

- Press the *MENU* button to access the top-level menu for the primary application (see Figure 5.1).
- Press a soft key to select the Quick Menu for the primary application (see Figure 5.2 below).



NOTE: Figure 5.3 on page 34 shows the structure of the TWX Application menu, and Figure 5.4 on page 37 shows the structure of the System Menu.

The Main Menu

The Main Menu is the topmost menu in the menu hierarchy. It can be accessed by pressing the *MENU* button twice – the first press brings up the menu for the primary application, and the second press brings up the Main Menu.





OPERATING TIP: When a menu is displayed, pressing the *MENU* button invokes the menu that is directly above the current menu in the menu hierarchy. This is a convenient way of backing up if the wrong menu is inadvertently selected.

The System Menu and the menus for all applications can be accessed from the Main Menu. If more than three applications are enabled, the Main Menu will have additional pages of buttons. The *MENU* button allows the user to cycle through the pages of the Main Menu when it has more than one page of buttons.

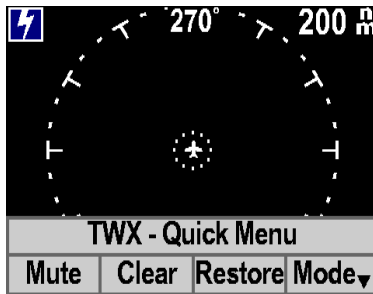

FIGURE 5.2

Quick Menu selections for the TWX Application

The Quick Menu

The concept of the Quick Menu is to provide a quick way for a pilot to access the most frequently used functions. Any one of the four soft keys brings up the Quick Menu, so this menu can be accessed with a single button press. Once the user is familiar with the items on the Quick Menu, the Quick Menu functions of the primary application can be accessed simply by pressing the associated soft key twice. The first press brings up the Quick Menu, and the second press selects the associated function. For instance, to select the audio mute function, simply press the leftmost soft key twice. The first press brings up the TWX Quick Menu, and the second press selects **Mute**. Figure 5.2 illustrates the TWX Quick Menu options.

The TWX Application Menu

The TWX Menu allows control over the display format of lightning data. A graphical depiction of the menu structure is shown in Figure 5.3 below. A short description of each menu item follows.

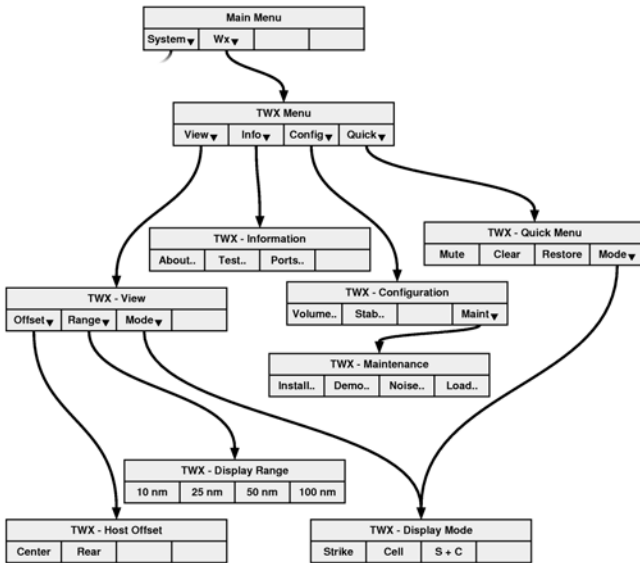

FIGURE 5.3
TWX
Application
menu
structure



CAUTION: Some menu dialogs require a password to access. These dialogs are restricted to qualified maintenance personnel only. Unauthorized access to password restricted dialogs may render the system inoperable.

TWX Menu

- View ▼** Invokes the **TWX - View** menu.
- Info ▼** Invokes the **TWX - Information** menu.
- Config ▼** Invokes the **TWX - Configuration** menu.
- Quick ▼** Invokes the **TWX - Quick Menu**.

TWX - View

- Offset ▼** Invokes the **TWX - Host Offset** menu.
- Range ▼** Invokes the **TWX - Display Range** menu.
- Mode ▼** Invokes the **TWX - Mode** menu.



TWX - Host Offset

- Center** Sets the display of the TWX Application so that the host symbol is placed at the center of the window, allowing a 360° view.
- Rear** Sets the display of the TWX Application so that the host is offset toward the bottom (rear) of the display, providing a forward-looking view.

TWX - Display Range

- 10, 25, 50, 100 nm** These options have the same effect as changing the display range with the *DATA/RNG* knob. The knob must be used to access the 200 nm range selection.

TWX - Display Mode

- Strike** Places the TWX display in Strike mode. Individual lightning strikes are depicted as dots.
- Cell** Places the TWX display in Cell mode. Individual lightning strikes are integrated into a colorized contour of storm activity.
- S + C** Places the TWX display in a combined Strike and Cell mode. Cell mode contours are displayed overlaid with flashing white dots representing the actual strikes making up the cell presentation.

TWX - Information

- About..** Invokes a dialog displaying the TWX670 serial number, software and hardware versions, part numbers, and build dates.
- Test..** Places the TWX670 in Test Mode causing the TWX670 to generate internal test strikes at a higher rate, and invokes a dialog allowing the user to view test strike processing, current warnings and errors, and a statistical history of past warnings and errors.
- Ports..** Invokes a dialog to displaying the current TWX670 external port assignments.

TWX - Configuration

- Volume..** Invokes a dialog allowing adjustment of the audio volume for TWX670 callouts.
- Stab..** Invokes a dialog allowing the user to manually enable/disable the use of heading input and GPS position for the display stabilization. This is normally used for disabling the use of data sources that are malfunctioning and thus resulting in an erratic TWX display.
- Maint▼** Invokes the **TWX - Maintenance** menu. All Maintenance menu items are password protected and should only be accessed by qualified maintenance personnel.

TWX - Quick Menu

Mute	Mutes TWX670 audio callouts for 3 minutes or until the Mute button is pressed again. A “Mute” indicator will be displayed if the TWX is the primary application.
Clear	Clears the display of all current strike and cell data
Restore	Restores all strikes and cell data that was previously cleared but has not yet expired (i.e., that has occurred within the last 3 minutes).
Mode ▼	Invokes the TWX - Display Mode menu.



The System Menu

Figure 5.4 shows the System Menu structure. More detailed information can be found in the *Avidyne Multi-Hazard Display Pilot Operating Handbook - General Information*. Press the *MENU* button twice to access the System Menu.

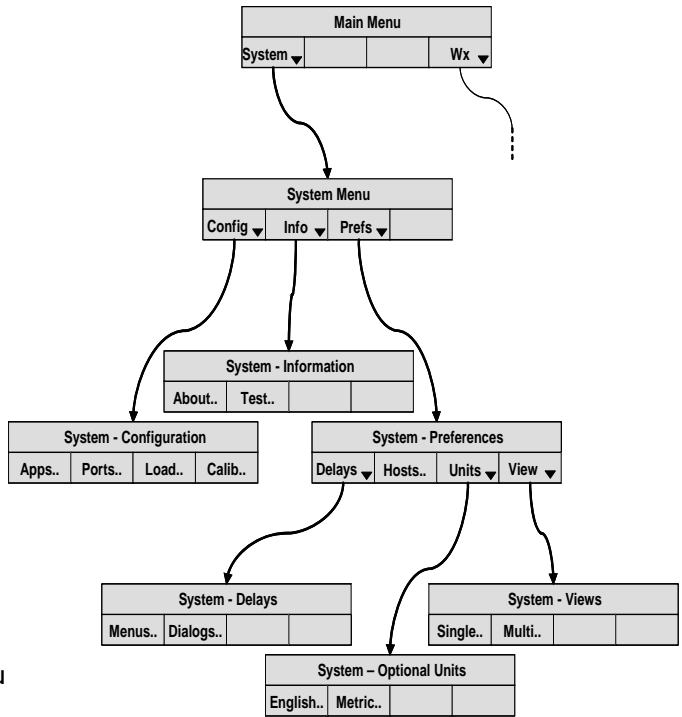

FIGURE 5.4
System Menu structure



(This page was intentionally left blank)



CHAPTER 6

Specifications & Warranty

General Specifications of the MHD

Weight	2.0 pounds (.9kg)
Operating Voltage:	10 - 30 Volts DC
Current:	1.0A @ 14VDC, 0.5A @ 28VDC
Dimming: LCD screen: Controls:	Left rotary knob. Instrument panel dimmer.

FIGURE 6.1
MHD
Specifications

Parts and Service Warranty

The Avidyne MHD is warranted against defects in materials and manufacturing for 18 months from date of shipment to an authorized dealer or one year from the date of original installation, whichever occurs first. The obligation of Avidyne Corporation is limited to the repair or replacement, at the option of Avidyne Corporation, of products that prove to be defective during the warranty period. No other warranty is expressed or implied. Proper installation of the Avidyne MHD is the responsibility of the installing agency and is not part of this warranty. Avidyne Corporation is not liable for consequential damages. Warranty protection is ensured only when the Avidyne MHD is installed and serviced by an authorized dealer.

Customer Support

We appreciate the confidence you have placed in Avidyne Corporation and in your avionics dealer. We trust that both the Avidyne MHD and your dealer have met your expectations. For questions or comments, contact Customer Service at:

1-800-877-0048 (USA and Canada)

1-614-885-3303 (International)

support@avidyne.com

Record of Purchase

The following information will be helpful should you contact Avidyne Corporation for service or support. For your convenience, we recommend that you record the information here for future reference.

TWX670 Processor Model:	
TWX670 Processor S/N:	
MHD S/N:	
Date of Purchase:	
Dealer Name:	

(This page was intentionally left blank)



CHAPTER 7

Appendices

Error and Warning Conditions

There are a number of error and warning conditions that can be annunciated on the weather display. Additional information regarding error and warning messages are described in Avidyne's *TWX670 Pilot Operating Handbook*.

Error Conditions

Error conditions that prevent the TWX670 from performing its normal function are annunciated in amber across the display screen. In this case, the display of weather data will be inhibited. Make note of the annunciated condition and provide the information to your qualified service personnel at the first opportunity. A list of the failure messages that may be seen and a description of each can be found in Table 1 below. Due to display space limitations, the annunciation will be abbreviated in the multiview main window, and even more so in the thumbnail windows. You can access the full failure description by pressing *MENU/Info/Test* when viewing the multiview main screen or the singleview screen.

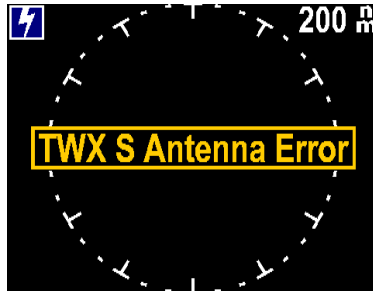

FIGURE 7.1

Error conditions are annunciated in a banner across the screen

Error Annunciation	Description
TWX H Antenna Error	The TWX670 has detected an antenna failure. The lighting display cannot be trusted.
TWX V Antenna Error	The TWX670 uses three antenna elements; the horizontal, vertical and sense antennas. These are identified as H, V, and S by the antenna error message respectively. If multiple antenna failures have been detected, then all of the letters associated with the failed antennas will be combined into a single antenna error message. The TWX670 installation should be checked by qualified service personnel at the first opportunity.
TWX S Antenna Error	
TWX Receiver Failure	
TWX Mic Inhibit Stuck	The TWX670 disables lightning detection when the microphone is keyed to eliminate transmitter induced noise. When the microphone remains keyed for 2 minutes or longer, this failure will be annunciated. It will clear if the Microphone Inhibit Input goes inactive. If the microphone stuck failure indication does not clear as expected, then the TWX670 installation should be checked by qualified service personnel at the first opportunity.
TWX Antenna Config	The TWX670 antenna configuration pins are not connected properly to identify whether a top or bottom mounted antenna is being used. The TWX670 installation should be checked by qualified service personnel at the first opportunity.
No TWX Data	A communications link from the display to the TWX670 has not been established. The TWX670 installation should be checked by qualified service personnel at the first opportunity.
TWX Link Lost	The communications link from the display to the TWX670 has been lost. The TWX670 installation should be checked by qualified service personnel at the first opportunity.
Port(s) Needed	This indicates that the port assignment for the TWX670 has not been configured in the MHD.

TABLE 1: TWX670 ERROR CONDITIONS.

Warning Conditions

Warning conditions that degrade, but do not prevent continued operation of the system, are annunciated with a “**Warn**” message in the upper left side of the display and by changing the host aircraft symbol into an amber ‘W’. When there is a new, unacknowledged warning, the “**Warn**” indication will be highlighted as shown in Figure 7.2.

Press *MENU/Info/Test* to determine the cause of the warning. This will also acknowledge the warning condition. Warnings that have been acknowledged are shown without being highlighted as shown in Figure 7.3.

A list of possible warning conditions and their interpretation can be found in Table 2 below.

FIGURE 7.2

New warning conditions are annunciated with a highlighted flag

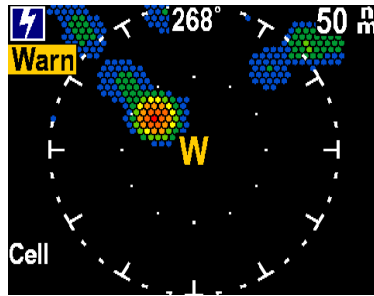
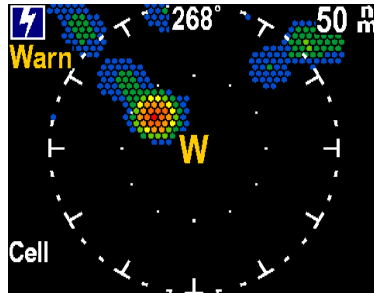

FIGURE 7.3

Existing warning conditions are annunciated without highlighting



Warning Message	Description
Wx data inaccurate (noise)	<p>Excessive noise has been detected in the system. Range and Bearing estimates may be degraded. System sensitivity may be degraded.</p> <p>You may be near an external noise source; moving away may eliminate the noise.</p> <p>If the problem persists, get your system checked by qualified service personnel at the first opportunity. Excessive noise can substantially affect the performance of the TWX system.</p>
Track & pos invalid (dev)	<p>The system is configured to interface with a position source, but it is not communicating with it.</p> <p>Position stabilization of storm data is not possible. If track data from the position source was used for heading stabilization, then heading stabilization is not possible.</p> <p>Make sure the position source is turned on and is operating. If the problem persists, get your system checked by qualified service personnel at the first opportunity.</p>
Track & pos invalid (data)	<p>The TWX670 is communicating with a position source, but there is no valid position data.</p> <p>Position stabilization of the storm data is not possible. If track data from the position source was used for heading stabilization, then heading stabilization is not possible.</p> <p>If you are on the ground, make sure the GPS antenna is not obstructed. Make sure your GPS receiver is locked and tracking.</p>
Heading invalid	<p>The system is configured to use a heading source for stabilization and there is no valid heading data. If your system has a position source providing valid track data, then the TWX670 will use track data for heading stabilization while heading data is unavailable.</p> <p>Make sure the heading source is turned on and is operating. If the problem persists, get your system checked by qualified service personnel at the first opportunity.</p>

TABLE 2: TWX670 WARNING CONDITIONS.

TWX670 Processor Failure

When the TWX display application powers up and detects that the TWX670 processor is not communicating, it displays a “**No TWX Data**” message across the screen and no lightning data is displayed (see Figure 7.4). If communication *had* been established and then lost, the message reads “**TWX Link Lost**” and lightning data is removed from the display. These messages are displayed on both the singleview screen and multiview main screen. In the thumbnail window, the messages are shortened to read “**No Data**” and “**No Link**”.

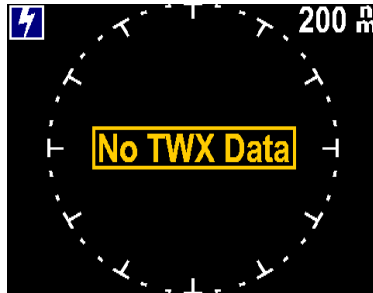

FIGURE 7.4

TWX670 processor
is not
communicating

Abnormal Operating Conditions

There are numerous other screen messages that are normally presented to the avionics technician during installation or maintenance operations. They should never be seen during normal operation of the TWX670. If you encounter such messages during normal operation, make note of the annunciation and notify your qualified service personnel at the first opportunity.

Glossary

The following terms are used throughout this document. For the purposes of this document, they have these definitions:

Glossary Term	Definition
Application	A program installed and operational in the MHD.
Cell mode	A display selection for the TWX Application for viewing lightning data that has been clustered into thunderstorm cells
Dialog	A window or screen that provides a means of adjusting certain parameters for the MHD or one of its applications.
Display Host	The Avidyne MHD. The aircraft equipped with the Avidyne MHD.
Menu	A display of button labels above the soft keys.
Menu mode	The mode of operation for the MHD when a menu is being displayed.
MFD	Multi-Function Display.
MHD	Multi-Hazard Display.
Multiview mode	An MHD display mode consisting of three windows - one large main window, and two smaller thumbnail windows - with each window capable of displaying a different application.
Primary Application	The display application shown on the screen in the singleview mode and the largest display in the multiview mode. The primary application in the multiview mode is not necessarily the primary application in the singleview mode.

Glossary Term	Definition
Processor	The portion of the TWX670 responsible for determining the relative position of lightning activity to the aircraft.
Secondary Application	An application that is not being displayed, or an application that is displayed in one of the two thumbnail windows in multiview mode.
Singleview mode	An MHD display mode in which an application is shown full screen.
Soft Key	The unlabeled buttons on the lower part of the MHD. The labels for the soft keys appear at the bottom of the LCD and change with the application and with button presses.
Strike mode	A display selection for the TWX Application for viewing lightning data as raw lightning strikes
Strike + Cell mode	A display selection for the TWX Application for viewing Cell mode with overlaid strike data.
Thumbnail window	The small application displays on the multiview mode display.



Index

A

antenna, 45, 47
Antenna, 45
application, 49
 primary. *See* primary application
application identification, 24

B

buttons
 menu button, 12, 19, 32, 33, 37
 select button, 19, 20, 21

C

Cell mode, 7, 13, 26, 35, 49
 with overlaid strikes. *See* Strike +
 Cell mode
clear, 19, 29, 36, 45
communications, 45
Communications, 45
current, 40
customer support, 41

D

dialog, 49
dimming, 18, 19, 40
display range, 19, 25, 35

E

errors. *See* messages:errors

F

failure, 45

G

GPS, 47

H

hazards
 lightning, 45
heading, 12, 13, 28, 35, 47
horizontal, 45

I

icon, 24

K

knob
 DATA/RNG knob, 12, 13
 VIEW/BRT knob, 18
 VIEW/BRT knob, 12

L

lightning, 45
lightning data, 24, 29, 34, 48
link, 45
Link, 45

M

menu
 button. *See* buttons:menu button
 Main Menu, 32
 maintenance, 35
 path, 7
 Quick Menu, 12, 20, 26, 32, 33,
 36
 System Menu, 24, 33, 37
 TWX Application menu, 34
 TWX Display Mode menu, 35

- TWX Display Range menu, 26, 35
- TWX Host Offset menu, 35
- TWX Information menu, 35
- TWX View menu, 34
- menu mode, 8, 19, 20, 49
- messages
 - errors, 44
 - No Data, 48
 - No Link, 48
 - No TWX Data, 48
 - TWX Link Lost, 48
 - Warn, 46
 - warnings, 46
- microphone, 45
- multiview main window, 21
- multiview mode, 12, 20, 21, 49
- mute, 36

N

- noise, 45, 47

O

- offset, 24, 25, 34
 - center, 24
 - rear, 24, 25

P

- parts, 40
- path. *See* menu:path
- position, 47
- power off, 18, 19
- power on, 18, 19
- primary application, 49

R

- range, 47
- range ring, 25
- receiver, 45, 47
- region data, 27, 28

- repair, 40
- restore, 29, 36
- revision index, 6

S

- secondary application, 50
- SEL*. *See* buttons:select button
- sense, 45
- service, 45, 47
- singleview mode, 12, 20, 50
- soft keys, 7, 12, 20, 32, 50
- stabilization
 - heading stabilization, 47
 - position, 47
- Strike + Cell mode, 27, 35, 50
- Strike mode, 12, 13, 26, 35, 50
- sunglasses, 7
- symbol, host aircraft, 24, 25

T

- thumbnail window, 12, 21, 48, 50
- thunderstorm data, 19, 26
- TSO, 6, 7
- TWX670
 - pilot's guide, 6, 17, 44
 - processor, 12, 17, 41, 48

V

- vertical, 45
- views
 - multiview. *See* multiview mode
 - singleview. *See* singleview mode
- voltage, 40

W

- warning**, 9, 47
- warnings. *See* messages:warnings
- warranty, 39, 40
- weight, 40

